

CERTIFICATE

Certified Passive House Component

Component-ID 0496wi03 valid until 31st December 2026

Passive House Institute
Dr. Wolfgang Feist
64283 Darmstadt
Germany

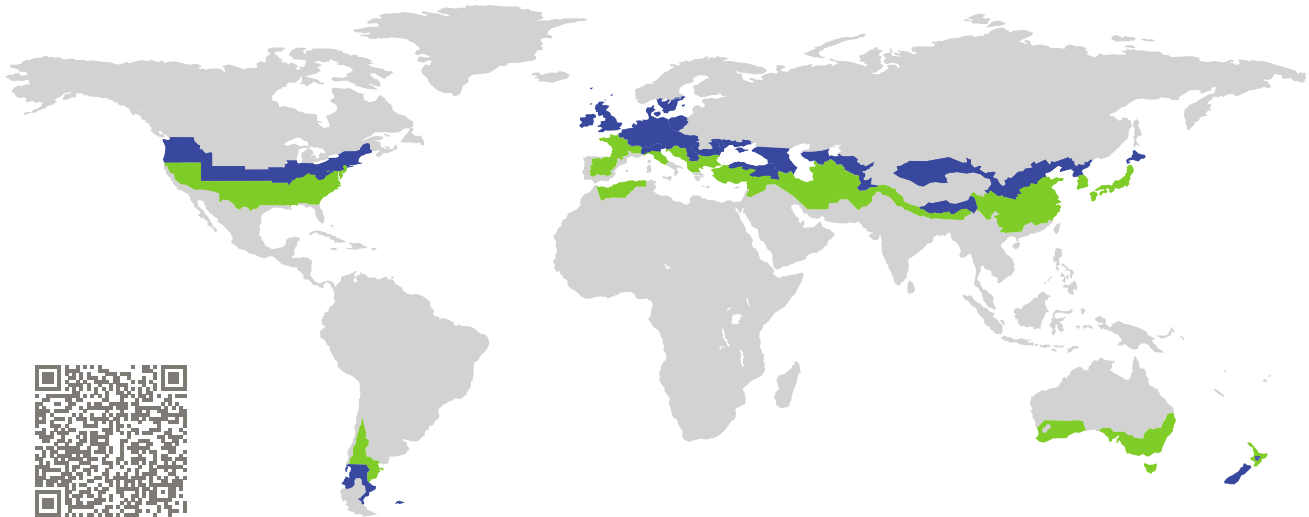

Category: **Window Frame**
Manufacturer: **Uniform S.p.A.,
Minerbe (VR),
Italy**
Product name: **Termoscudo Easy Line**

**This certificate was awarded based on the following
criteria for the cool, temperate climate zone**

Comfort $U_W = 0.78 \leq 0.80 \text{ W}/(\text{m}^2 \text{ K})$
 $U_{W, \text{installed}} \leq 0.85 \text{ W}/(\text{m}^2 \text{ K})$
with $U_g = 0.70 \text{ W}/(\text{m}^2 \text{ K})$

Hygiene $f_{R_{Si=0.25}} \geq 0.70$

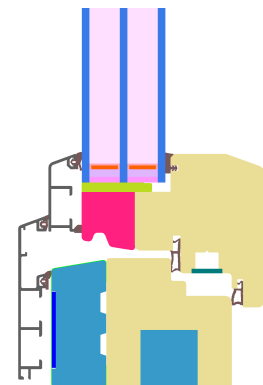

Passive House
efficiency class

phE

phD

phC

phB

phA

www.passivehouse.com

cool, temperate climate



**CERTIFIED
COMPONENT**

Passive House Institute

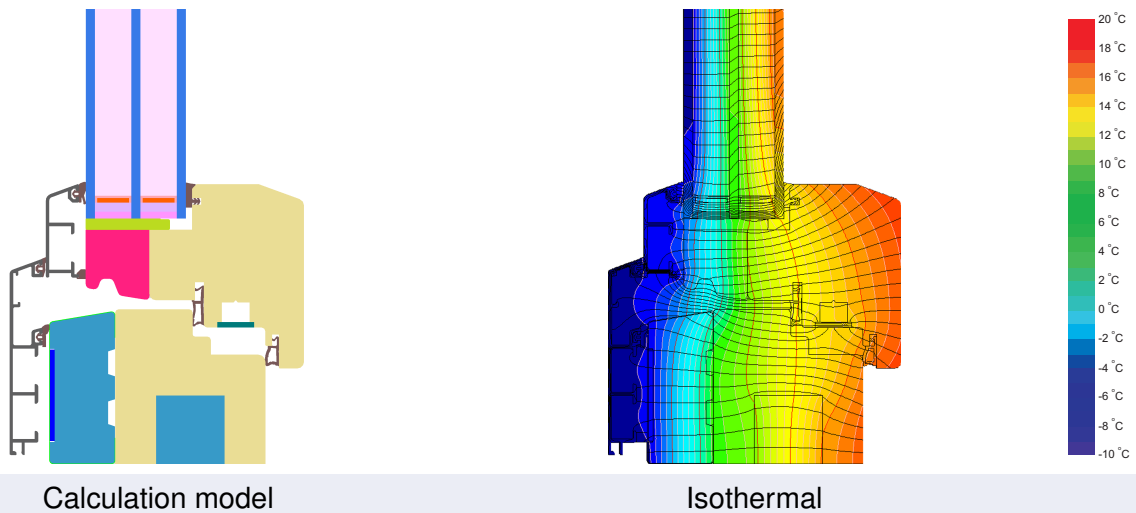

Description

Timberframe with facing-shell of aluminum. Insulation of extruded polystyrol. Pane thickness: 44 mm (4/16/4/16/4), Rebate depth: 15 mm.

Explanation





The window U-values were calculated for the test window size of 1.23 m × 1.48 m with $U_g = 0.70 \text{ W}/(\text{m}^2 \text{ K})$. If a higher quality glazing is used, the window U-values will improve as follows:

Glazing	$U_g =$	0.70	0.64	0.58	0.54	$\text{W}/(\text{m}^2 \text{ K})$
		↓	↓	↓	↓	
Window	$U_W =$	0.78	0.74	0.70	0.68	$\text{W}/(\text{m}^2 \text{ K})$

Transparent building components are classified into efficiency classes depending on the heat losses through the opaque part. The frame U-Values, frame widths, thermal bridges at the glazing edge, and the glazing edge lengths are included in these heat losses. A more detailed report of the calculations performed in the context of certification is available from the manufacturer.

The Passive House Institute has defined international component criteria for seven climate zones. In principle, components which have been certified for climate zones with higher requirements may also be used in climates with less stringent requirements. In a particular climate zone it may make sense to use a component of a higher thermal quality which has been certified for a climate zone with more stringent requirements.

Further information relating to certification can be found on www.passivehouse.com and passipedia.org.

Frame values		Frame width b_f mm	U -value frame U_f W/(m ² K)	Ψ -glazing edge Ψ_g W/(m K)	Temp. Factor $f_{RSI=0.25}$ [-]
Flying Mullion (FM1)		186	0.84	0.028	0.70
Bottom (OB1)		123	0.75	0.028	0.70
Head (OH1)		123	0.75	0.028	0.70
Jamb (OJ1)		123	0.75	0.028	0.70
		Spacer: SWISSPACER V		Secondary seal: Polysulfide	

Validated installations

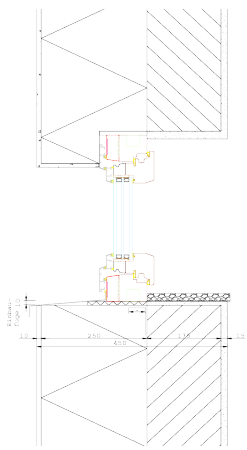
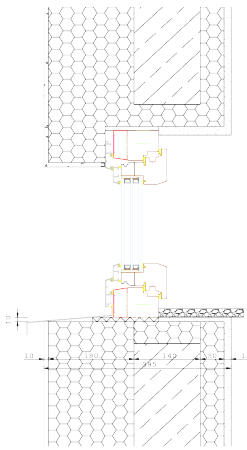
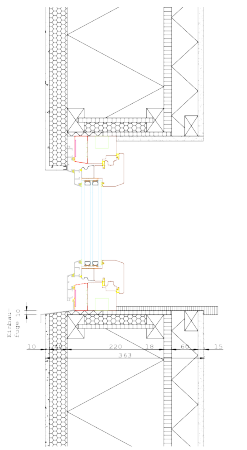
Exterior insulation and finishing system (EIFS) (operable)		Formwork blocks (operable)		Lightweight timber (operable)	
					
$\Psi_{install}$	W/(m K)	$\Psi_{install}$	W/(m K)	$\Psi_{install}$	W/(m K)
Top	0.019	Top	0.010	Top	0.021
Side	0.019	Side	0.010	Side	0.021
Bottom	0.027	Bottom	0.019	Bottom	0.026
$U_{W,installed} = 0.85$ W/(m ² K)		$U_{W,installed} = 0.82$ W/(m ² K)		$U_{W,installed} = 0.85$ W/(m ² K)	

Disclaimer: The Passive House Institute GmbH (PHI) conducts heat-transfer analyses in accordance with the standards set out in Criteria and Algorithms for Certified Passive House Components: Transparent Building Components and Opening Elements in the Building Envelope, based on information provided by the manufacturer. PHI does not verify on-site implementation. It is the responsibility of the project leader to ensure that installed components match the certified specifications in terms of geometry, configuration, and materials. Manufacturers must make full product information available upon request to parties involved in a construction project. These parties may compare the provided information with project documentation and perform on-site inspections as part of the quality-assurance process.

